

***** CAL. FSXX MOV'T PARTS LIST *****

ORIGINAL PARTS, MADE IN JAPAN

PART NAME	FS00/01	FS10/11	FS20/21
ANTI MAGNETIC PLATE	186-920	186-920	186-920
BATTERY	280-3908	280-3908	280-3908
BATTERY CONNECTOR SPRING	231-381	231-381	231-381
CALENDAR CORRECTOR LEVER	116-121	116-126	116-126
CALENDAR CORRECTOR WHEEL	-	213-540	213-540
CALENDER PLATE	-	714-051	714-051
CANNON PINION WITH DRIVING WHEEL	028-337	028-345	028-345
CENTER WHEEL COCK	711-202	711-202	711-202
CHRONOGRAPH COIL UNIT 1	246-207	246-207	246-207
CLUTCH WHEEL	064-670	064-670	064-670
COIL UNIT	246-207	246-207	246-207
DATE DIAL	108-F4XX	108-F4XX	108-F4XX
DATE DIAL DRIVING WHEEL	103-993	103-993	103-993
DATE DIAL GUARD	293-126	293-129	293-129
DATE JUMPER	109-630	109-730	109-730
DAY DIAL DRIVING WHEEL	-	-	-
DIAL GUARD	713-139	-	-
DAY JUMPER	-	-	-
DAY WHEEL	-	-	-
ELECTRIC CIRCUIT UNIT	279-E83	279-E83	279-E83
FIFTH WHEEL AND PINION	084-900	084-900	084-900
FLY-BACK LEVER	260-117	260-117	260-117
24 HOUR DRIVING WHEEL	100-690	100-700	100-700
FORTH WHEEL AND PINION	023-376	023-376	023-376
HOURLY WHEEL	075-542	075-556	075-556
INTERMEDIATE MINUTE WHEEL	087-138	087-138	087-138
INTERMEDIATE DATE CORRECTING WHEEL	087-620	087-620	087-620
INTERMEDIATE DATE CORRECTING WHEEL 2	-	087-217	087-217
INTERMEDIATE DATE CORRECTING WHEEL 3	-	087-235	087-235
INTERMEDIATE DAY WHEEL 1	-	-	-
INTERMEDIATE DAY WHEEL 2	-	-	-
INTERMEDIATE FLY-BACK WHEEL	087-229	087-234	087-234
INTERMEDIATE SECOND-RECORDING WHEEL 1	087-226	087-226	087-226
INTERMEDIATE SECOND-RECORDING WHEEL 2	087-227	087-227	087-227
INTERMEDIATE MINUTE WHEEL	087-138	087-138	087-138
INTERMEDIATE MINUTE-RECORDING WHEEL	087-228	087-228	087-228
INTERMEDIATE DATE WHEEL	087-231	087-231	087-231
JUMPER SPRING FOR INTERMEDIATE DAY WHEEL	-	-	-
LEVER STOPPER	117-290	117-290	117-290
MINUTE RECORDING WHEEL	291-100	291-110	291-110
MINUTE WHEEL AND PINION	072-132	072-132	072-132
PUSH BUTTON SPACER (FOR FS01/FS11/FS21)	282-960	282-960	282-960
ROTOR	285-232	285-232	285-232
ROTOR FOR CHRONOGRAPH	285-233	285-233	285-233
SCREW FOR CENTER WHEEL COCK (X2)	923-980	923-980	923-980
SCREW FOR CHRONOGRAPH GURD 1	930-650	930-650	930-650
SCREW FOR CHRONOGRAPH GURD 2(x3)	929-490	929-490	929-490
SCREW FOR DATE DIAL GUARD (X3)	929-480	929-640	929-640
SCREW FOR ELECTRIC CIRCUIT (X2)	922-166	922-166	922-166
SCREW FOR TRAIN WHEEL BRIDGE 1	923-980	923-980	923-980
SCREW FOR TRAIN WHEEL BRIDGE 2	934-470	934-470	934-470
SECOND CHRONOGRAPH WHEEL	251-230	251-240	251-240
SECONDS WHEEL	025-118	025-119	025-119
SETTING LEVER	067-993	067-993	067-993
SETTING LEVER SPRING	019-270	019-270	019-270
SETTING STEM	065-549	065-549	065-549
SETTING WHEEL	076-680	076-680	076-680
SPACER FOR SETTING STEM	212-301	212-309	212-309
STATOR	190-203	190-203	190-203
STATOR FOR CHRONOGRAPH 1	190-205	190-205	190-205
STOP LEVER	204-550	204-570	204-570
SUPPORTER FOR PLATE COMPLETE	226-508	226-508	ht
SUPPORTOR FOR CHRONOGRAPH PLATE	720-568	720-593	720-595
SUPPORTER FOR CHRONOGRAPH PLATE SPRING	903-228	903-228	903-228
THIRD WHEEL AND PINION	017-171	017-171	017-171
TRAIN WHEEL BRIDGE	701-F39	701-F39	701-F39
YOKE	071-144	071-144	071-144
LONGER SETTING STEM(24.00MM)	065-557	065-557	065-557

CAL.FS00/01 FS10/11 FS20/21

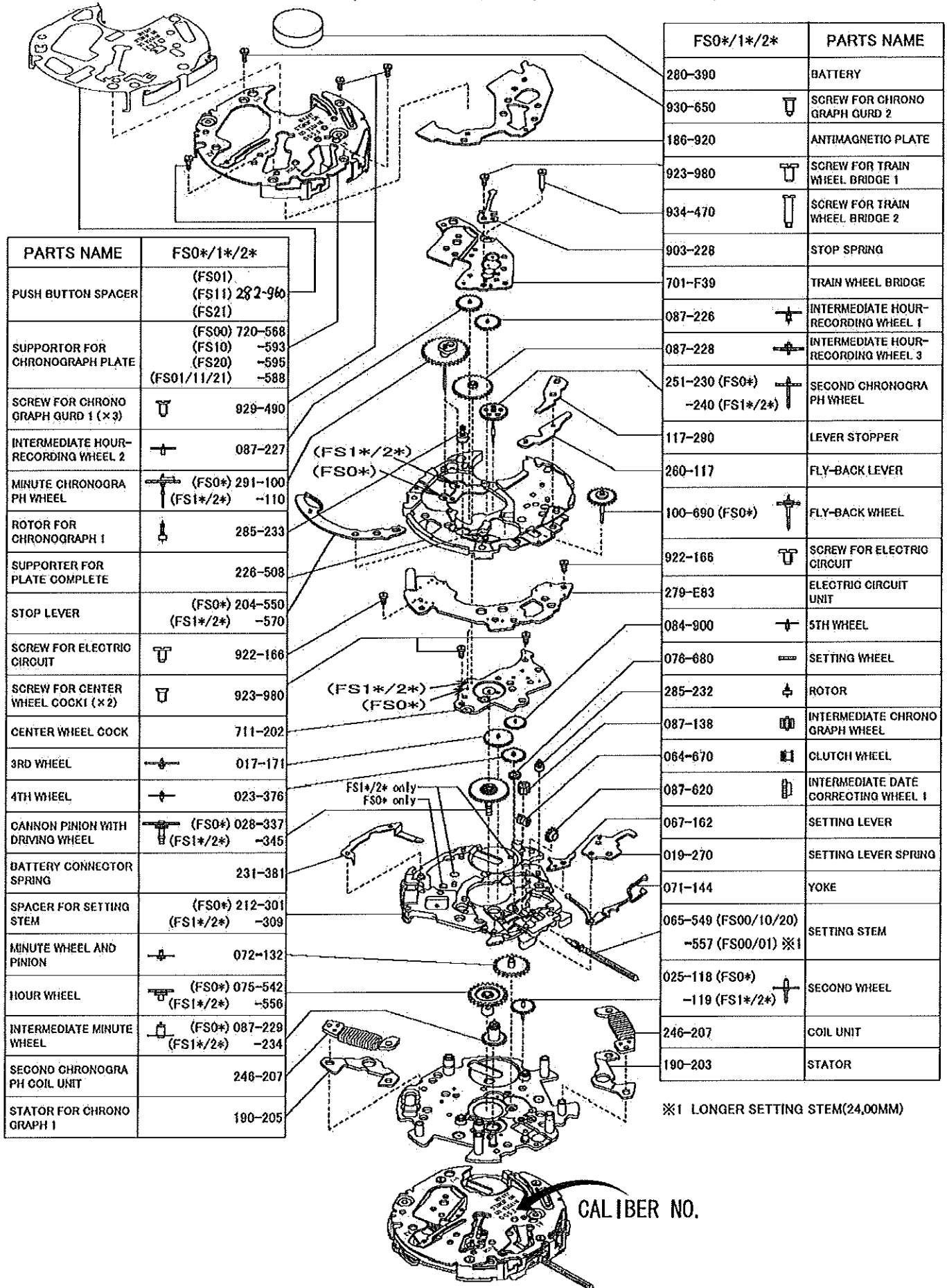

PARTS NAME	FS0*/1*/2*
PUSH BUTTON SPACER	(FS01) 282-960 (FS11) 282-960 (FS21)
SUPPORTOR FOR CHRONOGRAPH PLATE	(FS00) 720-588 (FS10) -593 (FS20) -595 (FS01/11/21) -588
SCREW FOR CHRONOGRAPH GURD 1 (x3)	929-490
INTERMEDIATE HOUR-RECORDING WHEEL 2	087-227
MINUTE CHRONOGRAPH WHEEL	(FS0*) 291-100 (FS1*/2*) -110
ROTOR FOR CHRONOGRAPH 1	285-233
SUPPORTER FOR PLATE COMPLETE	226-508
STOP LEVER	(FS0*) 204-550 (FS1*/2*) -570
SCREW FOR ELECTRIC CIRCUIT	922-166
SCREW FOR CENTER WHEEL COCK1 (x2)	923-980
CENTER WHEEL COCK	711-202
3RD WHEEL	017-171
4TH WHEEL	023-376
CANNON PINION WITH DRIVING WHEEL	(FS0*) 028-337 (FS1*/2*) -345
BATTERY CONNECTOR SPRING	231-381
SPACER FOR SETTING STEM	(FS0*) 212-301 (FS1*/2*) -309
MINUTE WHEEL AND PINION	072-132
HOUR WHEEL	(FS0*) 075-542 (FS1*/2*) -558
INTERMEDIATE MINUTE WHEEL	(FS0*) 087-229 (FS1*/2*) -234
SECOND CHRONOGRAPH COIL UNIT	246-207
STATOR FOR CHRONOGRAPH 1	190-205





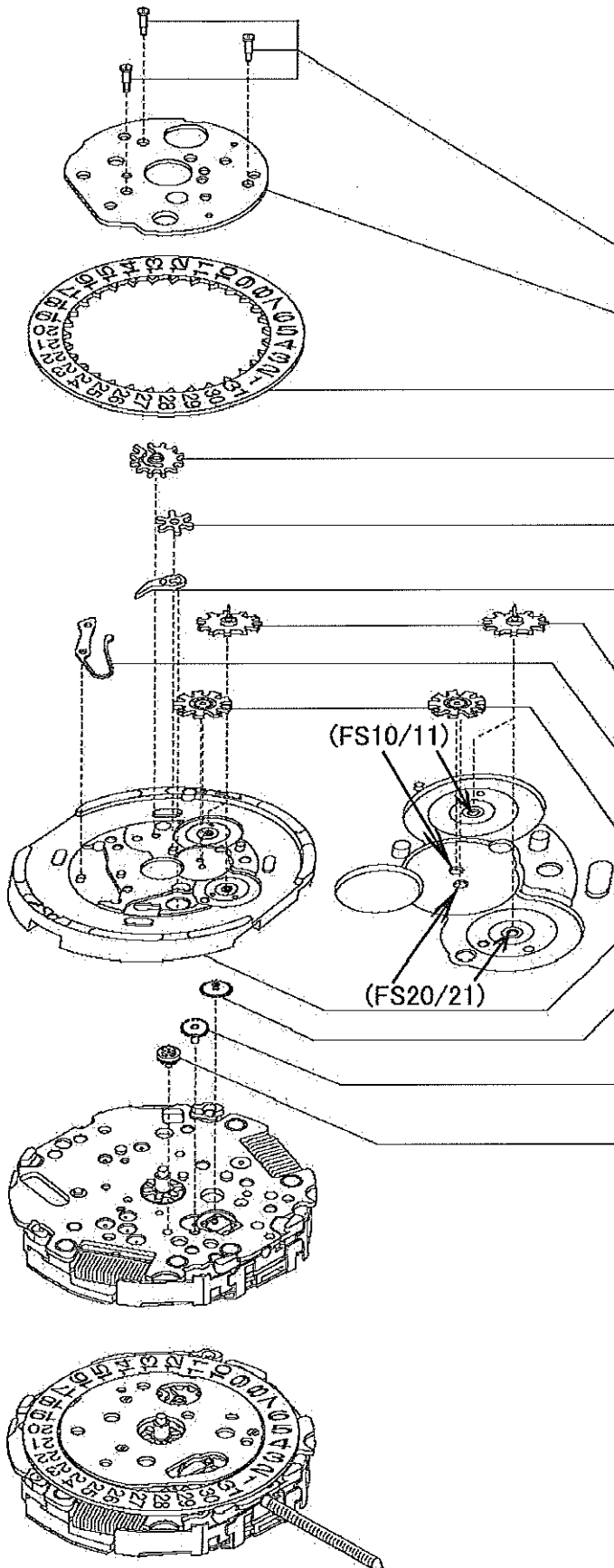

FS0*/1*/2*	PARTS NAME
280-390	BATTERY
930-650	SCREW FOR CHRONOGRAPH GURD 2
186-920	ANTIMAGNETIC PLATE
923-980	SCREW FOR TRAIN WHEEL BRIDGE 1
934-470	SCREW FOR TRAIN WHEEL BRIDGE 2
903-228	STOP SPRING
701-F39	TRAIN WHEEL BRIDGE
087-226	INTERMEDIATE HOUR-RECORDING WHEEL 1
087-228	INTERMEDIATE HOUR-RECORDING WHEEL 3
251-230 (FS0*) -240 (FS1*/2*)	SECOND CHRONOGRAPH WHEEL
117-280	LEVER STOPPER
260-117	FLY-BACK LEVER
100-690 (FS0*)	FLY-BACK WHEEL
922-166	SCREW FOR ELECTRIC CIRCUIT
279-E83	ELECTRIC CIRCUIT UNIT
084-900	5TH WHEEL
076-680	SETTING WHEEL
285-232	ROTOR
087-138	INTERMEDIATE CHRONOGRAPH WHEEL
064-670	CLUTCH WHEEL
087-620	INTERMEDIATE DATE CORRECTING WHEEL 1
067-162	SETTING LEVER
019-270	SETTING LEVER SPRING
071-144	YOKE
065-549 (FS00/10/20) -557 (FS00/01) ※1	SETTING STEM
025-118 (FS0*) -119 (FS1*/2*)	SECOND WHEEL
246-207	COIL UNIT
190-203	STATOR

※1 LONGER SETTING STEM(24,00MM)

CALIBER NO.

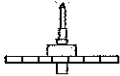
CAL.FS10/11/20/21



FS10/11/20/21		PARTS NAME
929-640		SCREW FOR DATE DIAL GUARD(×3)
293-129		DATE DIAL GUARD 1
108-F4X		DATE DIAL
103-993		DATE DIAL DRIVING WHEEL
087-231		INTEMEDATE DRIVING WHEEL
116-126		CALENDAR CORRECTOR LEVER
100-700		FLY-BACK WHEEL
109-730		DATE JUMPER
087-234		INTERMEDIATE MINUTE WHEEL
714-051		CALENDAR PLATE
087-217		INTERMEDIATE DATE CORRECTING WHEEL 2
087-235		INTERMEDIATE DATE CORRECTING WHEEL 3
213-540		CALENDAR CORRECTOR WHEEL

型号FS00/01 FS10/11 FS20/21

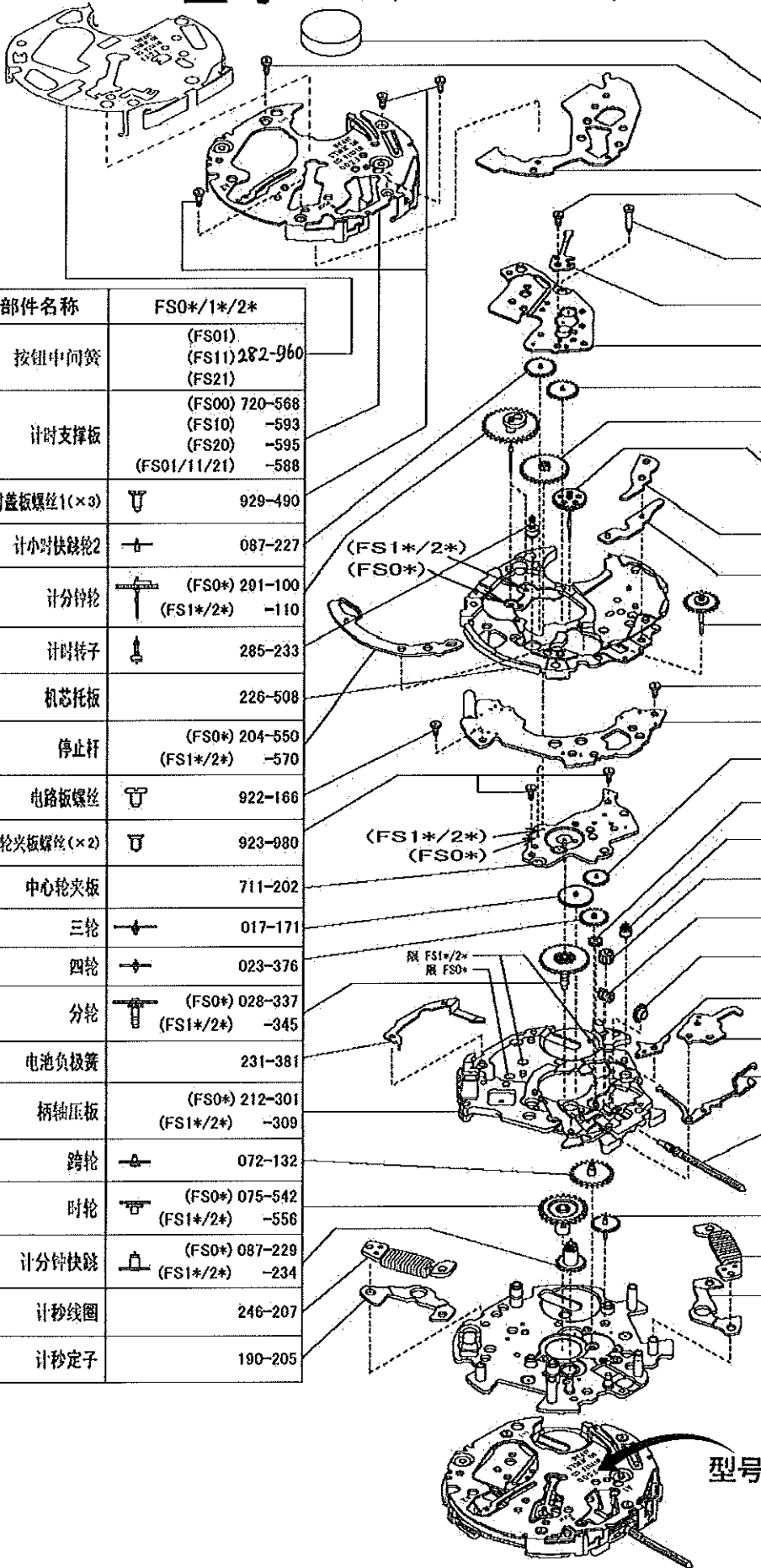

部件名称	FS0*/1*/2*
按钮中间簧	(FS01) 282-960 (FS11)
计时支撑板	(FS00) 720-568 (FS10) -593 (FS20) -595 (FS01/11/21) -588
计时盖板螺丝1(×3)	929-490
计小时快跳轮2	087-227
计分钟轮	(FS0*) 291-100 (FS1*/2*) -110
计时转子	285-233
机芯托板	226-508
停止杆	(FS0*) 204-550 (FS1*/2*) -570
电路板螺丝	922-166
中心轮夹板螺丝(×2)	923-980
中心轮夹板	711-202
三轮	017-171
四轮	023-376
分轮	(FS0*) 028-337 (FS1*/2*) -345
电池负极簧	231-381
柄轴压板	(FS0*) 212-301 (FS1*/2*) -309
跨轮	072-132
时轮	(FS0*) 075-542 (FS1*/2*) -556
计分钟快跳	(FS0*) 087-229 (FS1*/2*) -234
计秒线圈	246-207
计秒定子	190-205

FS0*/1*/2*	部件名称
280-380	电池
930-850	计时盖板螺丝2
186-920	防磁板
923-980	夹板螺丝1
934-470	夹板螺丝2
903-228	制停簧片
701-F39	夹板
087-228	计小时快跳轮1
087-228	计小时快跳轮3
251-230 (FS0*) -240 (FS1*/2*)	计秒轮
117-290	制停杆
260-117	归位杆
100-690 (FS0*)	归位轮
922-166	电路板螺丝
279-E83	电路板
084-900	五轮
076-680	拨针轮
285-232	转子
087-138	计时快跳轮
084-670	离合轮
087-620	日历修正快跳轮1
087-162	拉档
019-270	拉档压板簧
071-144	离合杆
065-549 (FS00/10/20) -557 (FS00/01) ※1	柄轴
025-118 (FS0*) -119 (FS1*/2*)	秒轮
246-207	线圈
190-203	定子

※1 长柄轴(24.00MM)

型号

型号FS10/11/20/21

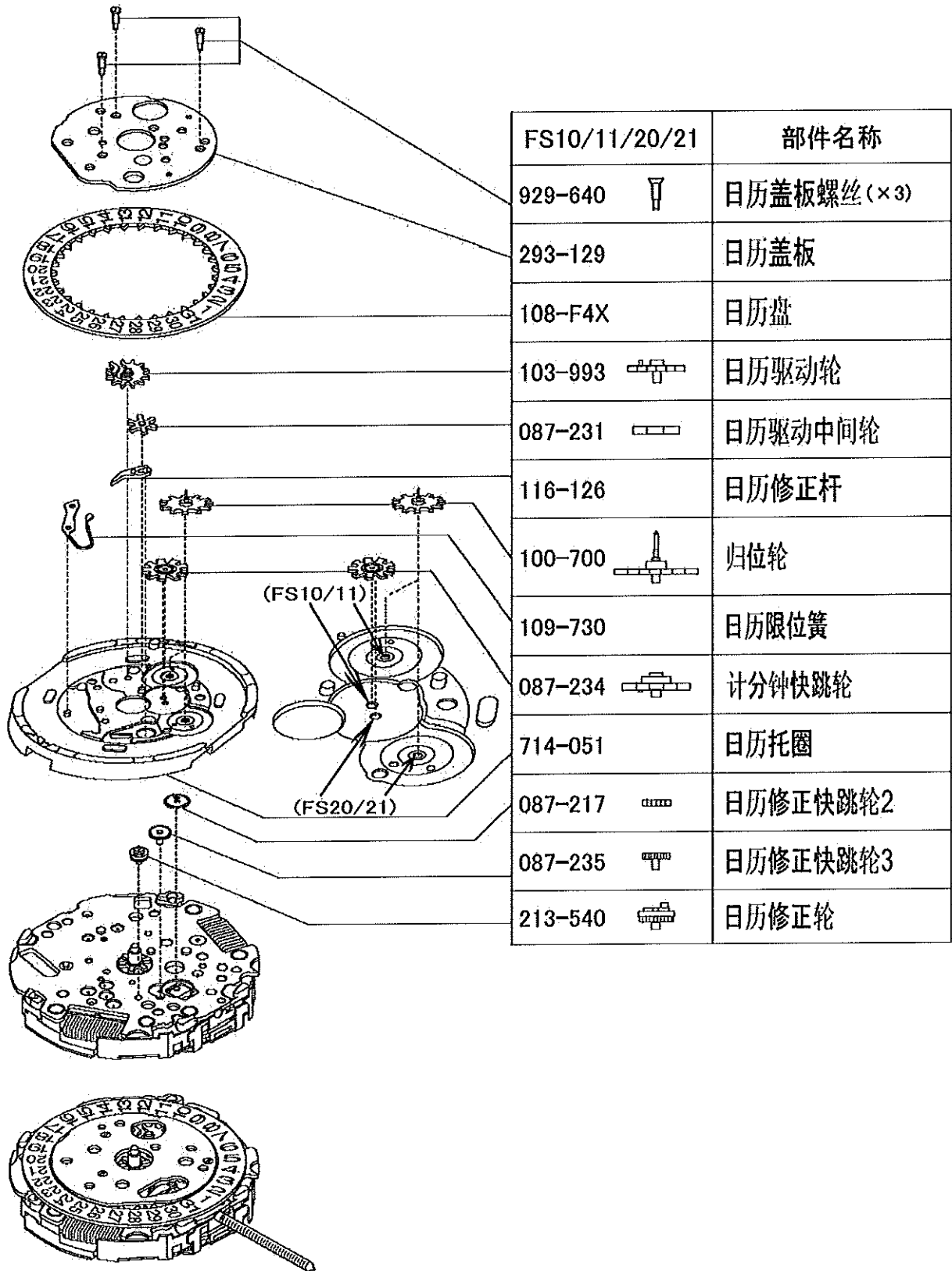

FS10/11/20/21		部件名称
929-640		日历盖板螺丝(×3)
293-129		日历盖板
108-F4X		日历盘
103-993		日历驱动轮
087-231		日历驱动中间轮
116-126		日历修正杆
100-700		归位轮
109-730		日历限位簧
087-234		计分钟快跳轮
714-051		日历托圈
087-217		日历修正快跳轮2
087-235		日历修正快跳轮3
213-540		日历修正轮